

SPECIFICATION

Dimmable Wet Location LED Linear Flex System:

AQUAFLEX provides stable, consistent, energy efficient, ultra flexible solid state lighting. With a super low-profile it is able to meet any custom length at the designated cutting points. AQUAFLEX is housed in a high quality silicone sleeve and has available mounting clips and end caps for simple installation. See MODA Metal® for extrusion options.



Dimensions:

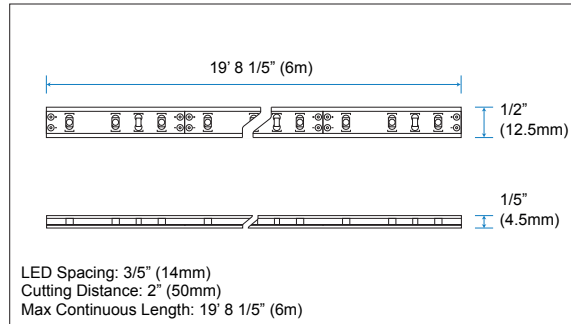

Output:

Delivered Lumens	13.33 lm / ft
CCT	N/A
Chromaticity Ordinates	x: 0.1421 y: 0.0448 u: 0.1747 v: 0.1239
Color Bin Tolerance	+ 3% / - 3%
Efficacy (lm/w)	10.50
Wavelength	470nm
Lumen Maintenance	70,000 Hours L70 @ 25°C : 90,000 Hours L50 @ 25°C 50,000 Hours L70 @ 50°C : 70,000 Hours L50 @ 50°C
Testing Data	Light Data LM-79-08 & LM-80-08

Illuminance at a Distance: Data Shown for 120°

(For lux multiply fc by 10.7)

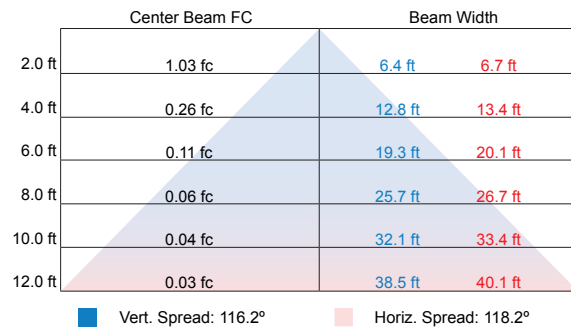

Electrical:

Input Voltage	12v DC
Power Consumption	1.27w / ft (0.11A) - Varies based on length of run & driver
Power Factor	≤ 1
Dimming	100-277v 0-10v & Magnetic Low Voltage
Emergency	N/A

Polar Candela Distribution:

Data Shown for 120°

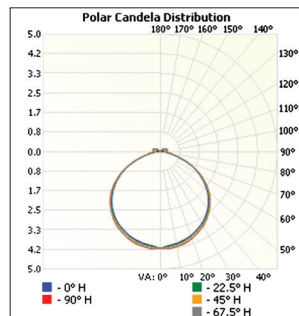

Lumens per Zone:

Zone	Lumens	% Total
0-10	0.39	2.93%
10-20	1.13	8.48%
20-30	1.74	13.05%
30-40	2.16	16.20%
40-50	2.30	17.25%
50-60	2.11	15.83%
60-70	1.57	11.78%
70-80	0.82	6.15%
80-90	0.31	2.33%
90-100	0.23	1.73%

Physical:

Applications	Wet Locations, Cabinet, Cove, Display, Niches, Perimeter Lighting
Dimensions	Length 19' 8 1/5" (6m) Width 1/2" (12.5mm) Height 1/5" (4.5mm)
Weight	14.4 oz (408.2g) Per Reel
Construction	Constant Voltage Design Protects LEDs And Prolongs Life. White FPCB Inside a Silicone Sleeve
Thermal Management	N/A
Optics	N/A
Fixture Connections	Solder joints
Operating Temperature	-22°F ~ 122°F (-30°C ~ 70°C)
Storage Temperature	-40°F ~ 176°F (-40°C ~ 80°C)
Humidity	0-95% Non Condensing

Project Name:			
Notes:			

SPECIFICATION

Zonal Lumen Summary:

Zone	Lumens	% Lamp	% Fixt
0-30	3.26	N.A.	24.50%
0-40	5.41	N.A.	40.60%
0-60	9.82	N.A.	73.70%
60-90	2.39	N.A.	17.90%
0-90	12.53	N.A.	94.00%
90-180	0.80	N.A.	6.00%
0-180	13.33	N.A.	100%

Luminance Data (cd/sq.m):

Angle in Degrees	Average 0-Deg	Average 45-Deg	Average 90-Deg
45	1495	1052	947
55	1439	898	792
65	1290	681	576
75	928	391	315
85	721	175	133

CIE 1931 Chromaticity Diagram:

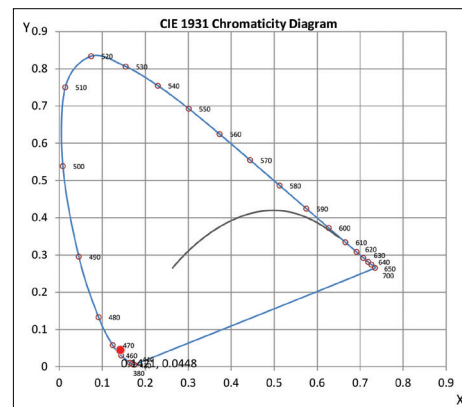



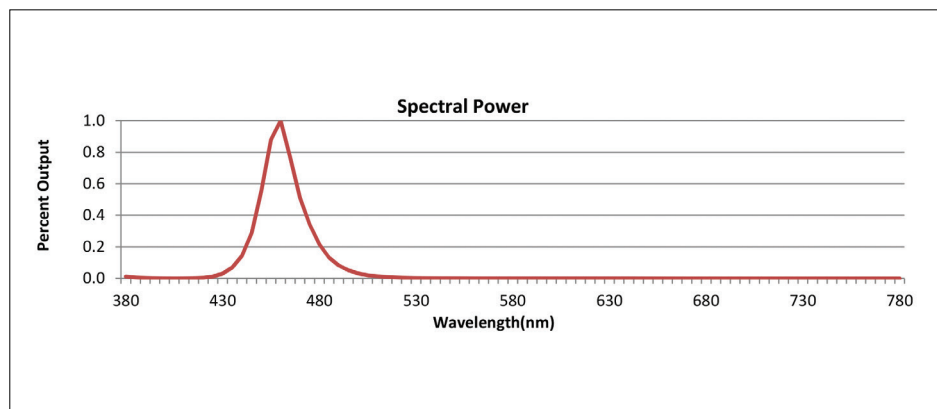

Spectral Power:

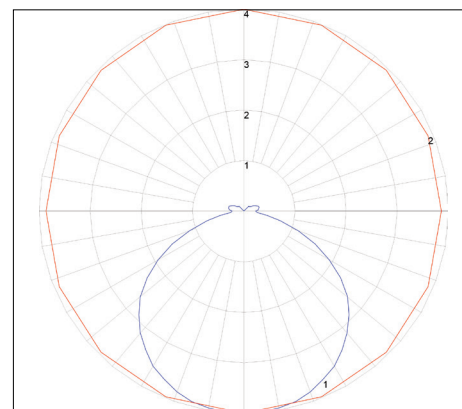

Polar Graph: Data Shown for 120°



Accessories:

			
MRTA61 Mounting Clips	MRTA63 End Cap	MRTA62 3oz 3M Marine Grade Super Silicone Sealant	MRTA62-XL 1/10 gal 3M Marine Grade Super Silicone Sealant
Screws Into Surface To Hold AQUAFLEX-BLUE	Terminates AQUAFLEX-BLUE To Protect FPCB From Dust or Water	Applied Between AQUAFLEX-BLUE, Connectors or End Caps to Seal From Exposure to Moisture	Applied Between AQUAFLEX-BLUE, Connectors or End Caps to Seal From Exposure to Moisture
L: 1 1/5" (30mm) W: 1/5" (5mm) H: 1/5" (5mm) 2 Screws 1/2" (13mm)	L: 3/5" (15mm) W: 1/5" (5mm) H: 1/5" (5mm)		

Standards and Certifications:





Certification	Tested to UL & CSA by ETL For Use in USA & CANADA, Complies with California Title 24 Requirements, Lighting Facts. Exceeds ANSI C78.377A, CE & RoHS Compliant.
Class	Class 3
Environment	Wet Location - IP67
Warranty	5 Year Limited Warranty

Ordering:

SKU: AQUAFLEX-BLUE

SPECIFICATION

Non Dimming		Voltage Range	Wattage	IP Rating	Dimension
MP16		100-277v AC	132w	IP67	8 7/10" x 2 7/10" x 1 1/2" (222mm x 68mm x 39mm)

0-10v Dimming		Voltage Range	Wattage	IP Rating	Dimension
MP05		347v AC	60w	IP66	9 2/5" x 1 7/10" x 1 3/10" (240mm x 43mm x 32mm)
MP18N		100-277v AC	60w	IP66	9 2/5" x 1 7/10" x 1 3/10" (240mm x 43mm x 32mm)
MP86		100-277v AC	100w	IP66	9 1/2" x 2 3/10" x 1 1/2" (241mm x 58mm x 37mm)
MP88		100-277v AC	150w	IP66	9 1/2" x 2 3/5" x 1 3/5" (241mm x 67mm x 40.5mm)

Ordering:

Sample SKU: MP05