

## SPECIFICATION

### Dimmable Wet Location LED Linear Flex System:

AQUAFLEX provides stable, consistent, energy efficient, ultra flexible solid state lighting. With a super low-profile it is able to meet any custom length at the designated cutting points. AQUAFLEX is housed in a high quality silicone sleeve and has available mounting clips and end caps for simple installation. See MODA Metal® for extrusion options.



### Dimensions:

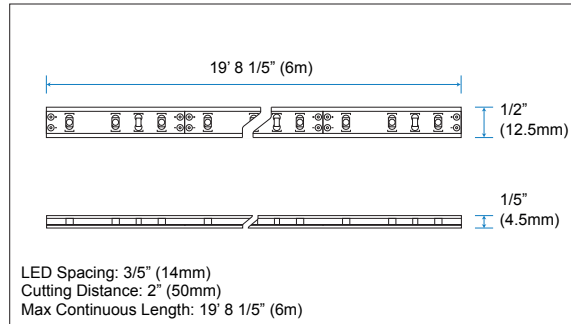

### Output:

Delivered Lumens	11.77 lm / ft
CCT	N/A
Chromaticity Ordinates	x: 0.6924 y: 0.3050 u: 0.5250 v: 0.5204
Color Bin Tolerance	+ 3% / - 3%
Efficacy (lm/w)	9.20
Wavelength	627nm
Lumen Maintenance	70,000 Hours L70 @ 25°C : 90,000 Hours L50 @ 25°C 50,000 Hours L70 @ 50°C : 70,000 Hours L50 @ 50°C
Testing Data	Light Data LM-79-08 & LM-80-08

### Illuminance at a Distance: Data Shown for 120°

(For lux multiply fc by 10.7)

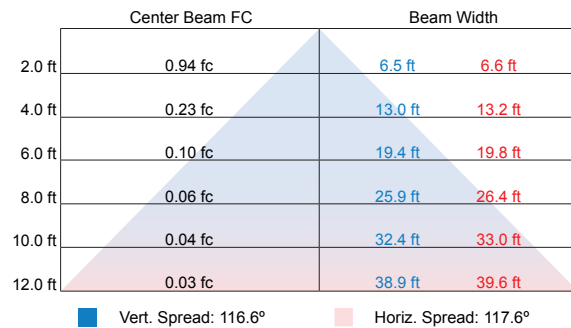

### Electrical:

Input Voltage	12v DC
Power Consumption	1.28w / ft (0.11A) - Varies based on length of run & driver
Power Factor	≤ 1
Dimming	100-277v 0-10v & Magnetic Low Voltage
Emergency	N/A

### Polar Candela Distribution:

Data Shown for 120°

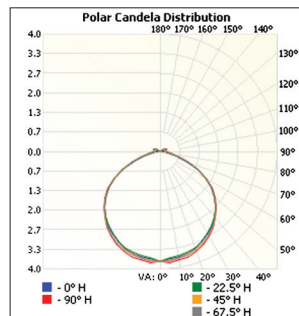

### Lumens per Zone:

Zone	Lumens	% Total
0-10	0.35	2.97%
10-20	1.02	8.67%
20-30	1.58	13.42%
30-40	1.95	16.57%
40-50	2.07	17.59%
50-60	1.90	16.14%
60-70	1.37	11.34%
70-80	0.69	5.86%
80-90	0.28	2.38%
90-100	0.18	1.53%

### Physical:

Applications	Wet Locations, Cabinet, Cove, Display, Niches, Perimeter Lighting
Dimensions	Length 19' 8 1/5" (6m) Width 1/2" (12.5mm) Height 1/5" (4.5mm)
Weight	14.4 oz (408.2g) Per Reel
Construction	Constant Voltage Design Protects LEDs And Prolongs Life. White FPCB Inside a Silicone Sleeve
Thermal Management	N/A
Optics	N/A
Fixture Connections	Solder joints
Operating Temperature	-22°F ~ 122°F (-30°C ~ 70°C)
Storage Temperature	-40°F ~ 176°F (-40°C ~ 80°C)
Humidity	0-95% Non Condensing

Project Name:			
Notes:			

# SPECIFICATION

## Zonal Lumen Summary:

Zone	Lumens	% Lamp	% Fixt
0-30	2.96	N.A.	25.10%
0-40	4.90	N.A.	41.60%
0-60	8.87	N.A.	75.40%
60-90	2.06	N.A.	17.50%
0-90	11.21	N.A.	95.20%
90-180	0.56	N.A.	4.80%
0-180	11.77	N.A.	100%

## Luminance Data (cd/sq.m):

Angle in Degrees	Average 0-Deg	Average 45-Deg	Average 90-Deg
45	1372	946	850
55	1346	810	720
65	1130	591	511
75	729	320	278
85	583	155	133

## CIE 1931 Chromaticity Diagram:

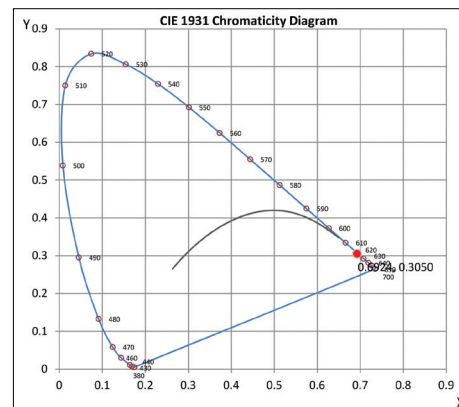



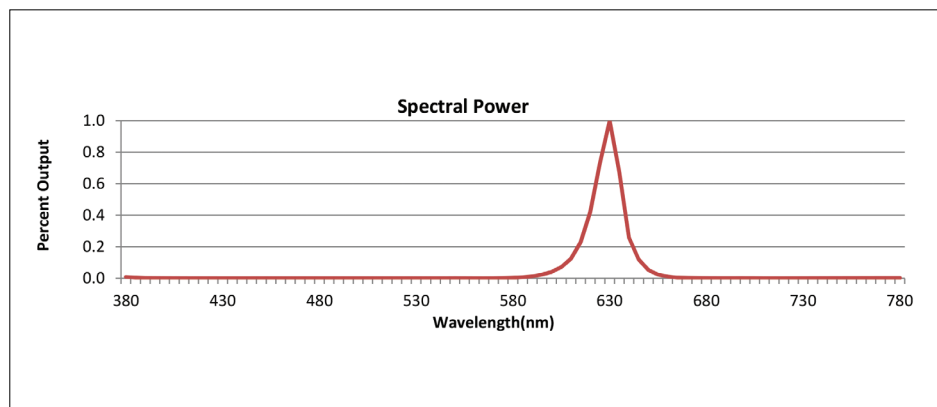

## Spectral Power:

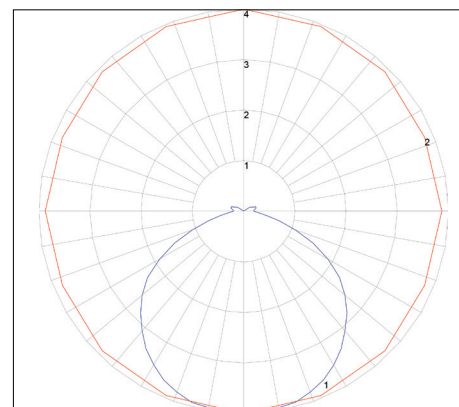

## Polar Graph: Data Shown for 120°



## Accessories:

			
<b>MRTA61</b> Mounting Clips	<b>MRTA63</b> End Cap	<b>MRTA62</b> 3oz 3M Marine Grade Super Silicone Sealant	<b>MRTA62-XL</b> 1/10 gal 3M Marine Grade Super Silicone Sealant
Screws Into Surface To Hold AQUAFLEX-RED	Terminates AQUAFLEX-RED To Protect FPCB From Dust or Water	Applied Between AQUAFLEX-RED, Connectors or End Caps to Seal From Exposure to Moisture	Applied Between AQUAFLEX-RED, Connectors or End Caps to Seal From Exposure to Moisture
L: 1 1/5" (30mm) W: 1/5" (5mm) H: 1/5" (5mm) 2 Screws 1/2" (13mm)	L: 3/5" (15mm) W: 1/5" (5mm) H: 1/5" (5mm)		

## Standards and Certifications:





Certification	Tested to UL & CSA by ETL For Use in USA & CANADA, Complies with California Title 24 Requirements, Lighting Facts. Exceeds ANSI C78.377A, CE & RoHS Compliant.
Class	Class 3
Environment	Wet Location - IP67
Warranty	5 Year Limited Warranty

## Ordering:

SKU:	AQUAFLEX-RED
------	--------------

### SPECIFICATION

Non Dimming		Voltage Range	Wattage	IP Rating	Dimension
MP16		100-277v AC	132w	IP67	8 7/10" x 2 7/10" x 1 1/2" (222mm x 68mm x 39mm)

0-10v Dimming		Voltage Range	Wattage	IP Rating	Dimension
MP05		347v AC	60w	IP66	9 2/5" x 1 7/10" x 1 3/10" (240mm x 43mm x 32mm)
MP18N		100-277v AC	60w	IP66	9 2/5" x 1 7/10" x 1 3/10" (240mm x 43mm x 32mm)
MP86		100-277v AC	100w	IP66	9 1/2" x 2 3/10" x 1 1/2" (241mm x 58mm x 37mm)
MP88		100-277v AC	150w	IP66	9 1/2" x 2 3/5" x 1 3/5" (241mm x 67mm x 40.5mm)

#### Ordering:

Sample SKU: MP05