

SPECIFICATION

FLATFLEX:

MODA's new low profile flexible lighting solution is just 1/5" (6mm) thick and has every component hidden to resemble a lighting fixture that bends like a flex. Free from shape memory, and flexes along it's line of light, delivering a multitude of design options. Dimming is easy with MODA Dimmable Drivers - choice of MLV or 0-10v dimming. Full line of accessories available, MODA Xtrusions, clips and simple leader and jumper cables. Clean lines with options of Black, White or Clear Finishes. Supplied in contractor ready 150ft (45.7m) reels. UL listed for use in USA & Canada.

Dimensions:

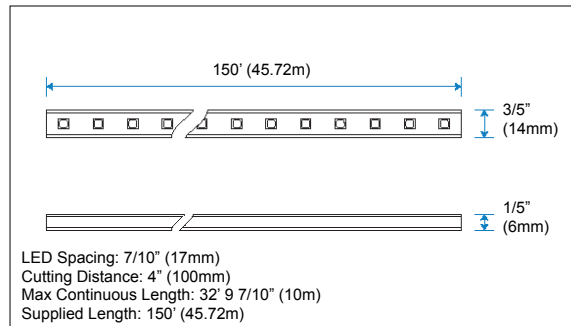

Output:

Delivered Lumens	44.38 lm / ft
CCT	N/A
Chromaticity Ordinates	x: 0.1305 y: 0.0687 u: 0.1465 v: 0.1735
Color Bin Tolerance	N/A
Efficacy (lm/w)	28.09
Wavelength	470nm
Lumen Maintenance	70,000 Hours L70 @ 25°C : 90,000 Hours L50 @ 25°C 50,000 Hours L70 @ 50°C : 70,000 Hours L50 @ 50°C
Testing Data	Light Data LM-79-08 & LM-80-08

Illuminance at a Distance: Data Shown for 150°

(For lux multiply fc by 10.7)

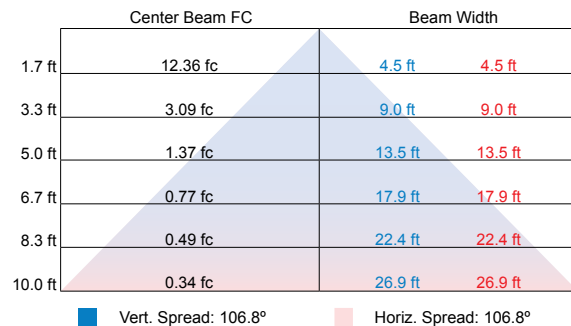

Electrical:

Input Voltage	24v DC
Power Consumption	1.58w (0.07A) - Varies based on length of run & driver
Power Factor	≤ 1
Dimming	100-277v 0-10v Magnetic Low Voltage
Emergency	N/A

Polar Candela Distribution:

Data Shown for 150°

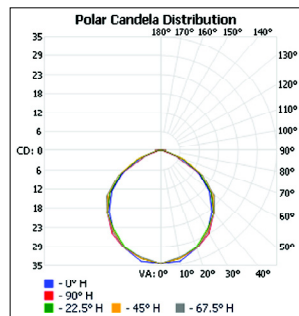

Lumens per Zone:

Zone	Lumens	% Total
0-10	1.55	3.50%
10-20	4.44	10.00%
20-30	6.66	15.00%
30-40	8.08	18.20%
40-50	8.43	19.00%
50-60	7.41	16.70%
60-70	4.84	10.90%
70-80	2.00	4.50%
80-90	0.67	1.50%
90-100	0.27	0.60%

Physical:

Applications	Cove, Kitchen Cabinet, Furniture, Signage
Dimensions	Length 150' Drum (45.72m) Width 3/5" (14mm) Height 1/5" (6mm)
Weight	14.3 lbs (6.48 Kg) Per Reel
Construction	Tough Polyepoxide UV Protected Body.
Thermal Management	N/A
Optics	N/A
Fixture Connections	Push To Fit Connectors
Operating Temperature	-4°F ~ 122°F (-20°C ~ 50°C)
Storage Temperature	-40°F ~ 176°F (-40°C ~ 80°C)
Humidity	0-95% Non Condensing

Project Name:			
Notes:			

SPECIFICATION

Zonal Lumen Summary:

Zone	Lumens	% Lamp	% Fixt
0-30	12.65	N.A.	28.50%
0-40	20.68	N.A.	46.60%
0-60	36.57	N.A.	82.40%
60-90	7.54	N.A.	17.00%
0-90	44.11	N.A.	99.40%
90-180	0.27	N.A.	0.60%
0-180	44.38	N.A.	100%

Luminance Data (cd/sq.m):

Angle in Degrees	Average 0-Deg	Average 45-Deg	Average 90-Deg
45	124425	126934	128063
55	119547	122563	123626
65	110282	112433	113798
75	94450	96421	97149
85	91586	97692	99600

CIE 1931 Chromaticity Diagram:

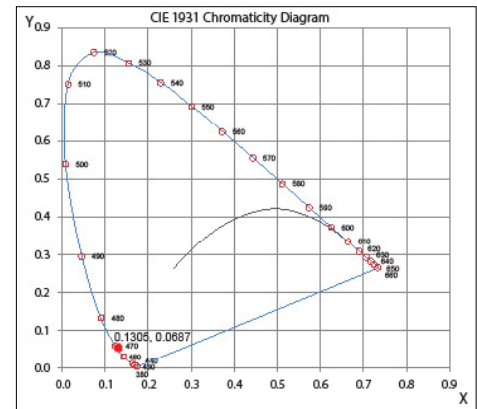

Spectral Power:

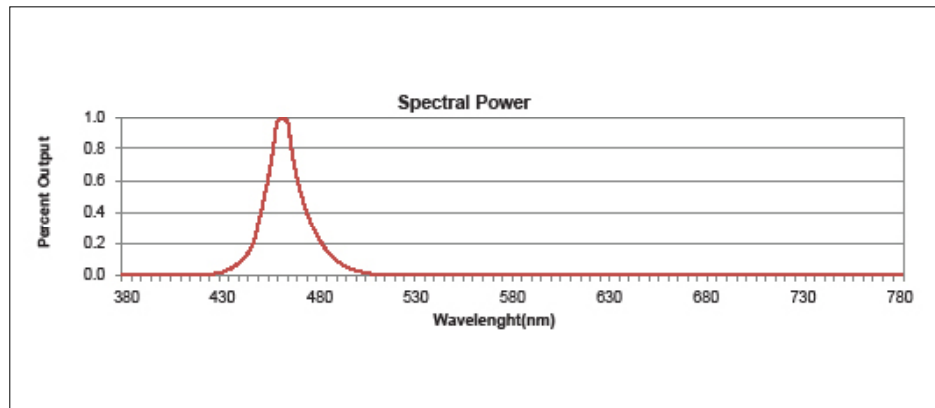

Polar Graph: Data Shown for 150°

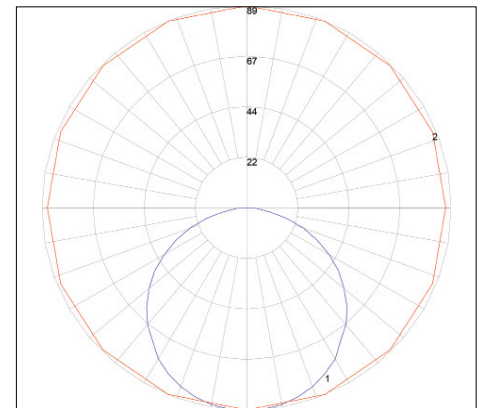

Accessories:

LEADER CABLE Power Lead for FLATFLEX	INLINE CONNECTOR Connector for FLATFLEX	JUMPER CABLE Connector for FLATFLEX	TERMINATOR	MOUNTING CLIP	FF-XTR-3FT	MP17 24v DC 150w	MP19 24v DC 100w	MP83 24v DC 150w	MP83-277v 24v DC 150w
Connects FLATFLEX To Power Supply	Connects Two FLATFLEX Together	Connects Two FLATFLEX and allows for corner bends	Terminates FLATFLEX To Protect FPCB From Dust	Screws Into Surface To Hold FLATFLEX	Screws Into Surface To Hold FLATFLEX	Wet Location LED Power Supply	0-10v Dimming LED Power Supply	MLV Dimming LED Power Supply	MLV Dimming LED Power Supply
Connector Dim: L: 1 1/2" (39mm) W: 3/5" (18mm) H: 2/5" (11mm) Finish: B-Black or W-White	Connector Dim: L: 1 1/2" (39mm) W: 3/5" (18mm) H: 2/5" (11mm) Finish: B-Black or W-White	Connector Dim: L: 1 1/2" (39mm) W: 3/5" (18mm) H: 2/5" (11mm) Finish: B-Black or W-White	L: 3/5" (17mm) W: 3/5" (18mm) H: 2/5" (11mm) Finish: B-Black or W-White	L: 1 1/5" (30mm) W: 1/5" (6mm) H: 3/10" (8mm) 2 Screws 1/2" (13mm)	L: 3' (914mm) W: 5/8" (16mm) h: 2/5" (10mm)	Non-Dimmable			

Options:

Product Name	Finish	Color Temp
FF	C - Clear Jacket W - White Jacket	B - BLUE

Standards and Certifications:

Certification	Tested to UL & CSA by ETL For Use in USA & CANADA, Complies with California Title 24 Requirements, Lighting Facts. Exceeds ANSI C78.377A, CE & RoHS Compliant.
Class	Class 3
Environment	Dry Location - IP40
Warranty	5 Year Limited Warranty

Ordering:

Sample SKU:	FF-B-BLUE-150FT
-------------	-----------------