

## SPECIFICATION

### FLATFLEX:

MODA's new low profile flexible lighting solution is just 1/5" (6mm) thick and has every component hidden to resemble a lighting fixture that bends like a flex. Free from shape memory, and flexes along it's line of light, delivering a multitude of design options. Dimming is easy with MODA Dimmable Drivers - choice of MLV or 0-10v dimming. Full line of accessories available, MODA Xtrusions, clips and simple leader and jumper cables. Clean lines with options of Black, White or Clear Finishes. Supplied in contractor ready 150ft (45.7m) reels. UL listed for use in USA & Canada.

### Dimensions:

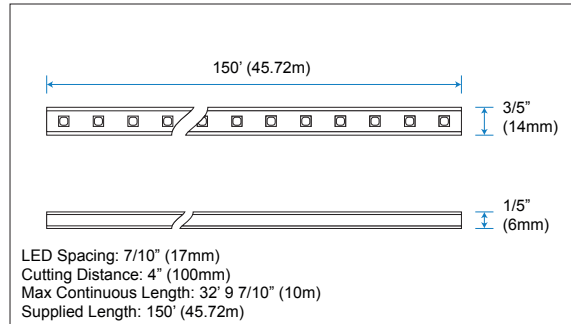

### Illuminance at a Distance:

Data Shown for 150°  
 (For lux multiply fc by 10.7)

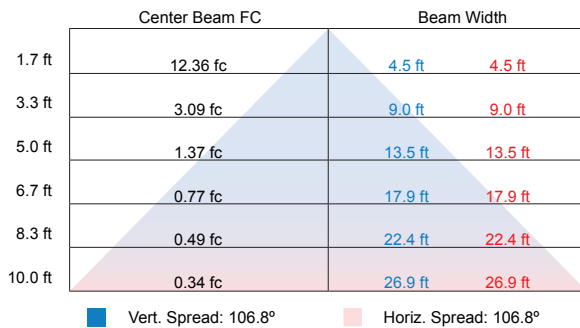

### Polar Candela Distribution:

Data Shown for 150°

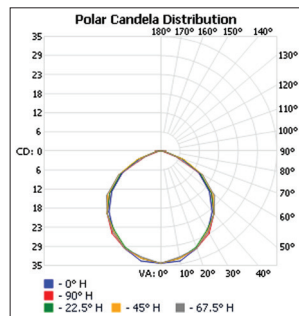

### Lumens per Zone:

| Zone   | Lumens | % Total |
|--------|--------|---------|
| 0-10   | 2.57   | 3.50%   |
| 10-20  | 7.34   | 10.00%  |
| 20-30  | 11.00  | 15.00%  |
| 30-40  | 13.35  | 18.20%  |
| 40-50  | 13.94  | 19.00%  |
| 50-60  | 12.25  | 16.70%  |
| 60-70  | 8.00   | 10.90%  |
| 70-80  | 3.30   | 4.50%   |
| 80-90  | 1.10   | 1.50%   |
| 90-100 | 0.44   | 0.60%   |



### Output:

|                        |  |
|------------------------|--|
| Delivered Lumens       | 73.36 lm / ft  |
| CCT                    | N/A  |
| Chromaticity Ordinates | x: 0.1564 y: 0.7272 u: 0.0548 v: 0.5734  |
| Color Bin Tolerance    | N/A  |
| Efficacy (lm/w)        | 46.43  |
| Wavelength             | 620nm  |
| Lumen Maintenance      | 70,000 Hours L70 @ 25°C : 90,000 Hours L50 @ 25°C<br>50,000 Hours L70 @ 50°C : 70,000 Hours L50 @ 50°C |
| Testing Data           | Light Data LM-79-08 & LM-80-08   |

### Electrical:

|                   |  |
|-------------------|--|
| Input Voltage     | 24v DC   |
| Power Consumption | 1.58w (0.07A) - Varies based on length of run & driver |
| Power Factor      | ≤ 1  |
| Dimming           | 100-277v 0-10v Magnetic Low Voltage                    |
| Emergency         | N/A  |

### Physical:

|                       |   |
|-----------------------|---|
| Applications          | Cove, Kitchen Cabinet, Furniture, Signage                           |
| Dimensions            | Length 150' Drum (45.72m)<br>Width 3/5" (14mm)<br>Height 1/5" (6mm) |
| Weight                | 14.3 lbs (6.48 Kg) Per Reel   |
| Construction          | Tough Polyepoxide UV Protected Body.                                |
| Thermal Management    | N/A   |
| Optics                | N/A   |
| Fixture Connections   | Push To Fit Connectors  |
| Operating Temperature | -4°F ~ 122°F (-20°C ~ 50°C)   |
| Storage Temperature   | -40°F ~ 176°F (-40°C ~ 80°C)  |
| Humidity              | 0-95% Non Condensing  |

|                      |  |  |  |
|----------------------|--|--|--|
| <b>Project Name:</b> |  |  |  |
| <b>Notes:</b>        |  |  |  |

# SPECIFICATION

## Zonal Lumen Summary:

| Zone   | Lumens | % Lamp | % Fixt |
|--------|--------|--------|--------|
| 0-30   | 20.91  | N.A.   | 28.50% |
| 0-40   | 34.19  | N.A.   | 46.60% |
| 0-60   | 60.45  | N.A.   | 82.40% |
| 60-90  | 12.47  | N.A.   | 17.00% |
| 0-90   | 72.92  | N.A.   | 99.40% |
| 90-180 | 0.43   | N.A.   | 0.60%  |
| 0-180  | 73.36  | N.A.   | 100%   |

## Luminance Data (cd/sq.m):

| Angle in Degrees | Average 0-Deg | Average 45-Deg | Average 90-Deg |
|------------------|---------------|----------------|----------------|
| 45               | 124425        | 126934         | 128063         |
| 55               | 119547        | 122563         | 123626         |
| 65               | 110282        | 112433         | 113798         |
| 75               | 94450         | 96421          | 97149          |
| 85               | 91586         | 97692          | 99600          |

## CIE 1931 Chromaticity Diagram:

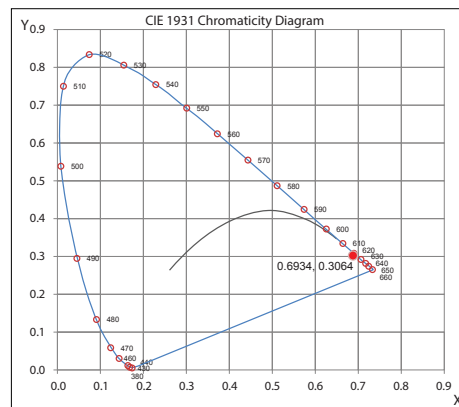



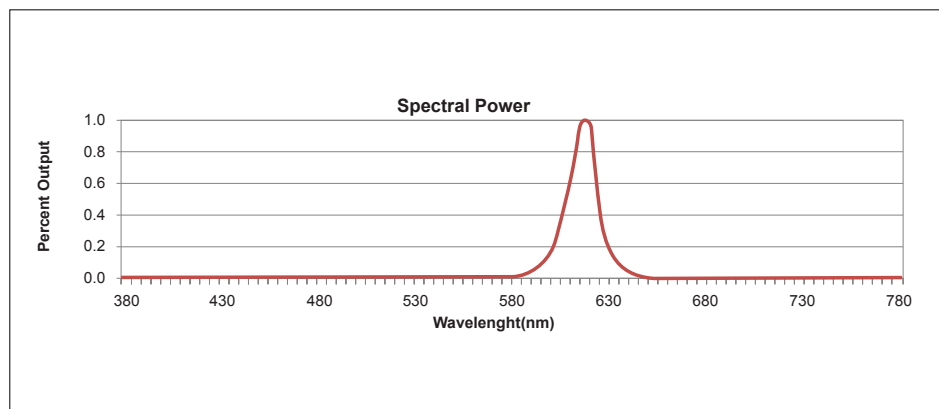

## Spectral Power:

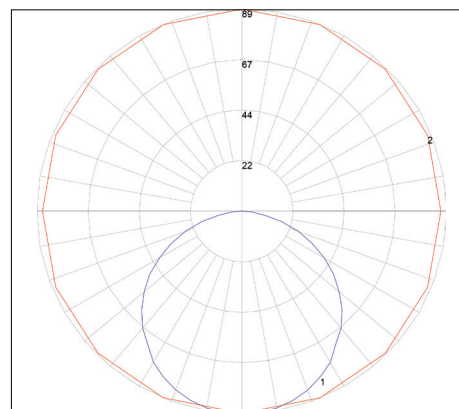

## Polar Graph: Data Shown for 150°

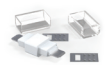

## Accessories:

|  |  |  |   |   |   |
|--|--|--|---|---|---|
|               |               |               |  |  |  |
| <b>LEADER CABLE</b><br>Power Lead for FLATFLEX   | <b>INLINE CONNECTOR</b><br>Connector for FLATFLEX  | <b>JUMPER CABLE</b><br>Connector for FLATFLEX  | <b>TERMINATOR</b><br>Terminator for FLATFLEX<br>(10 pcs)                            | <b>MOUNTING CLIP</b>  | <b>FF-XTR-3FT</b>   |
| Connects FLATFLEX To Power Supply  | Connects Two FLATFLEX Together   | Connects Two FLATFLEX and allows for corner bends  | Terminates FLATFLEX To Protect FPCB From Dust                                       | Screws Into Surface To Hold FLATFLEX  | Screws Into Surface To Hold FLATFLEX  |
| Connector Dim:<br>L: 1 1/2" (39mm)<br>W: 3/5" (18mm)<br>H: 2/5" (11mm)<br><br>Finish:<br>W-White | Connector Dim:<br>L: 1 1/2" (39mm)<br>W: 3/5" (18mm)<br>H: 2/5" (11mm)<br><br>Finish:<br>W-White | Connector Dim:<br>L: 1 1/2" (39mm)<br>W: 3/5" (18mm)<br>H: 2/5" (11mm)<br><br>Finish:<br>W-White | L: 3/5" (17mm)<br>W: 3/5" (18mm)<br>H: 2/5" (11mm)<br><br>Finish:<br>W-White        | L: 1 1/5" (30mm)<br>W: 1/5" (6mm)<br>H: 3/10" (8mm)<br>2 Screws 1/2" (13mm)           | L: 3' (914mm)<br>W: 5/8" (16mm)<br>H: 2/5" (10mm)                                     |

## Options:

| Product Name | Finish   | Color Temp |
|--------------|--|------------|
| FF           | B - Black Jacket<br>C - Clear Jacket<br>W - White Jacket | R - RED    |

## Standards and Certifications:





|               |  |
|---------------|--|
| Certification | Tested to UL & CSA by ETL For Use in USA & CANADA, Complies with California Title 24 Requirements, Lighting Facts. Exceeds ANSI C78.377A, CE & RoHS Compliant. |
| Class         | Class 3  |
| Environment   | Dry Location - IP40  |
| Warranty      | 5 Year Limited Warranty  |

## Ordering:

|             |                |
|-------------|----------------|
| Sample SKU: | FF-B-RED-150FT |
|-------------|----------------|

### SPECIFICATION

| Non Dimming |   | Voltage Range | Wattage | IP Rating | Dimension   |
|-------------|---|---------------|---------|-----------|---|
| MP17        |  | 100-277v AC   | 150w    | IP67      | 8 7/10" x 2 7/10" x 1 1/2"<br>(222mm x 68mm x 39mm) |

| 0-10v Dimming |  | Voltage Range | Wattage | IP Rating | Dimension   |
|---------------|--|---------------|---------|-----------|---|
| MP06          |   | 347v AC       | 60w     | IP66      | 9 2/5" x 1 7/10" x 1 3/10"<br>(240mm x 43mm x 32mm) |
| MP19N         |   | 100-277v AC   | 60w     | IP66      | 9 2/5" x 1 7/10" x 1 3/10"<br>(240mm x 43mm x 32mm) |
| MP87          |   | 100-277v AC   | 100w    | IP66      | 9 1/2" x 2 3/10" x 1 1/2"<br>(241mm x 58mm x 37mm)  |
| MP89          |  | 100-277v AC   | 150w    | IP66      | 9 1/2" x 2 3/5" x 1 3/5"<br>(241mm x 67mm x 40.5mm) |

#### Ordering:

Sample SKU: MP19N