

SPECIFICATION

RGB Modular Linear Product:

RGB ZILVA is a rigid LED linear system constructed using tri color LEDs allowing for smooth transitions and vivid colors. Built in 1 foot sections with quick connectors for easy modular connections of up to 30 feet of continuous illumination on one run.



Dimensions:

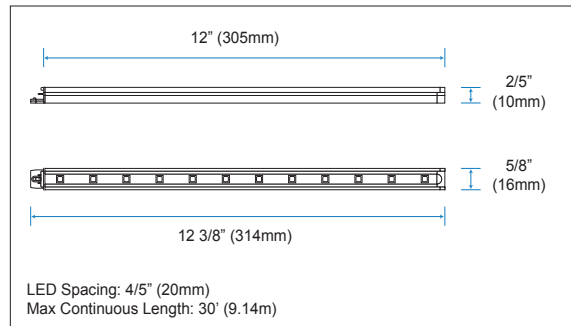

Output:

Delivered Lumens	79.58 lm / ft
CCT	26220 - Full RGB
Chromaticity Ordinates	x: 0.2684 y: 0.2364 u: 0.2026 v: 0.4014
Color Bin Tolerance	N/A
Efficacy (lm/w)	21.09
CRI	N/A
Lumen Maintenance	70,000 Hours L70 @ 25°C : 90,000 Hours L50 @ 25°C 50,000 Hours L70 @ 50°C : 70,000 Hours L50 @ 50°C
Testing Data	Light Data LM-79-08 & LM-80-08

Illuminance at a Distance: Data Shown for 120°

(For lux multiply fc by 10.7)

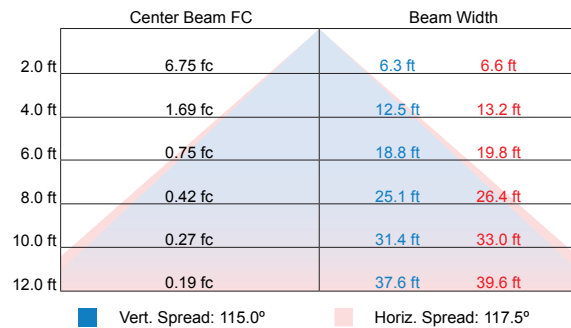

Electrical:

Input Voltage	24v DC
Power Consumption	3.77w (0.07A) - Varies based on length of run & driver
Power Factor	≤ 1
Dimming	DMX 512
Emergency	N/A

Polar Candela Distribution:

Data Shown for 120°

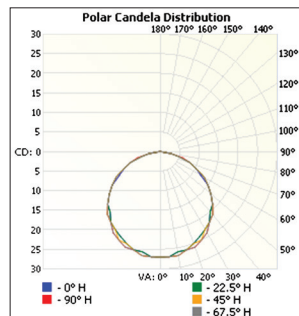

Lumens per Zone:

Zone	Lumens	% Total
0-10	2.56	3.22%
10-20	7.36	9.25%
20-30	11.32	14.22%
30-40	13.79	17.33%
40-50	14.61	18.36%
50-60	13.40	16.84%
60-70	10.12	12.72%
70-80	5.60	7.04%
80-90	0.82	1.03%
90-100	0.00	0.00%

Physical:

Applications	Cove, Cabinet, Niche, Display, Low Profile Installations, Furniture, and Signage
Dimensions	Length 12 3/8" (314mm) Width 5/8" (16mm) Height 2/5" (10mm)
Weight	2.3 oz (65.2g)
Construction	High Quality Anodized Aluminum
Thermal Management	MODA Aluminum Heat Sink
Optics	N/A
Fixture Connections	Modular Connectors
Operating Temperature	-22°F ~ 122°F (-30°C ~ 70°C)
Storage Temperature	-40°F ~ 176°F (-40°C ~ 80°C)
Humidity	0-95% Non Condensing

Project Name:			
Notes:			

SPECIFICATION

Zonal Lumen Summary:

Zone	Lumens	% Lamp	% Fixt
0-30	21.24	N.A.	26.70%
0-40	35.03	N.A.	44.00%
0-60	63.04	N.A.	79.20%
60-90	15.72	N.A.	19.80%
0-90	79.58	N.A.	100%
90-180	0.00	N.A.	0.00%
0-180	79.58	N.A.	100%

Luminance Data (cd/sq.m):

Angle in Degrees	Average 0-Deg	Average 45-Deg	Average 90-Deg
45	15704	15704	15704
55	15284	15284	15284
65	13829	13829	13829
75	11291	11291	13549
85	0	0	0

CIE 1931 Chromaticity Diagram:

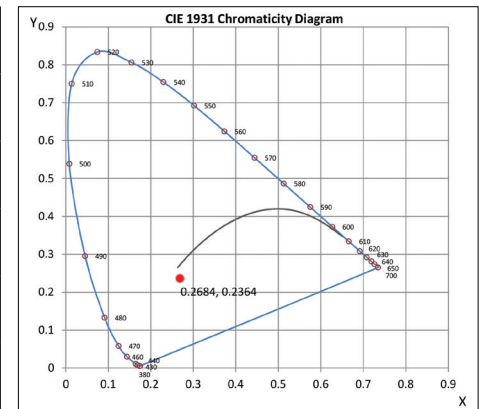

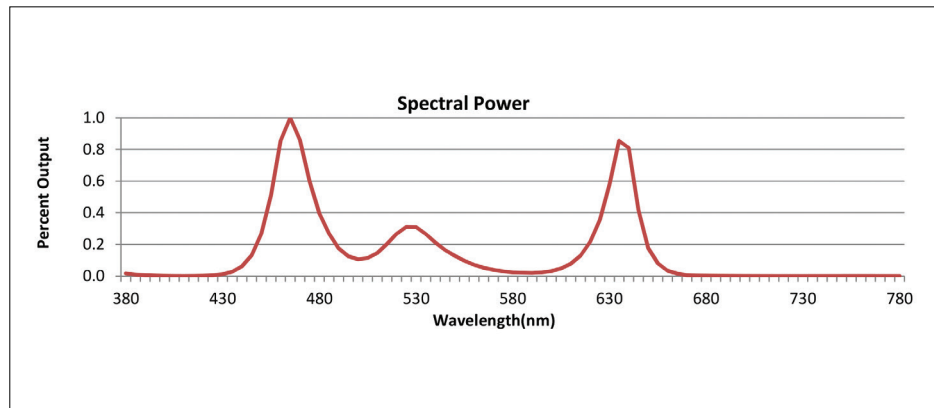

Spectral Power:

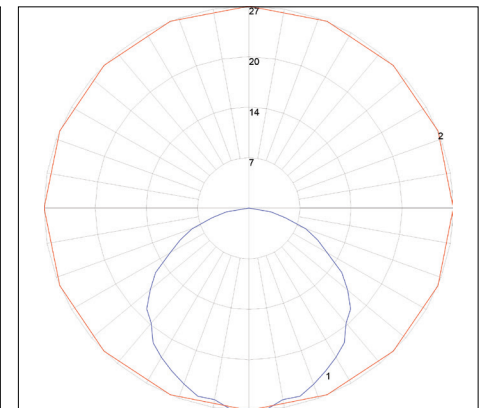

Polar Graph: Data Shown for 120°



Accessories:

		
MCLA03-RGB Male / Female Flexible Connector for 90° Bends	MCLA06 End Cap	MCLA04-RGB 3' Leader Cable for RGB-ZILVA
Connects Two RGB-ZILVA And Allows for 90° Sharp Corner Bends	Plugs Into RGB-ZILVA To Terminate Power Running Through Series	Connects RGB-ZILVA to Power Supply
Connector Dim. L: 2 1/5" (56mm) W: 3/5" (16mm) H: 2/5" (10mm)	L: 1/2" (13mm) W: 3/5" (15mm) H: 1/5" (5mm)	Connector Dim. L: 3/5" (16mm) W: 3/5" (16mm) H: 2/5" (10mm)

Standards and Certifications:

Certification	Tested to UL & CSA by ETL For Use in USA & CANADA, Complies with California Title 24 Requirements. Exceeds ANSI C78.377A, CE & RoHS Compliant.
Class	Class 3
Environment	Dry Location - IP20
Warranty	5 Year Limited Warranty

Ordering:

SKU: RGB-ZILVA

SPECIFICATION

DMX Controller		Voltage Range	Wattage	IP Rating	Dimension
KANDI TOUCH		6v DC	150w	IP20	4 1/5" x 5 7/10" 2/5" (106mm x 146mm x 11mm)

DMX Interface		Voltage Range	Wattage	IP Rating	Dimension
LD180		24v DC	180w	IP20	6" x 2" x 9/10" (152mm x 50mm x 23mm)

Non Dimming		Voltage Range	Wattage	IP Rating	Dimension
MP17		100-277v AC	150w	IP67	8 7/10" x 2 7/10" 1 1/2" (222mm x 68mm x 39mm)

Ordering:

Sample SKU: MP17
