

SPECIFICATION

Dimmable Low Profile LED Linear Flex System:

STARFLEX has set the standard for ultra flexible SSL illumination. Easy installation is achieved with simple hand tools and rapid push to fit connectors. Can be cut every 2 inches. Easy peel 3M backing for fixing to most surfaces. High light output. No UV or IR. Dimmable with choice of MODA drivers. A perfect low energy, low heat output solution for cove, niche, cabinet and display applications. See MODA Metal® for extrusion options.



Dimensions:

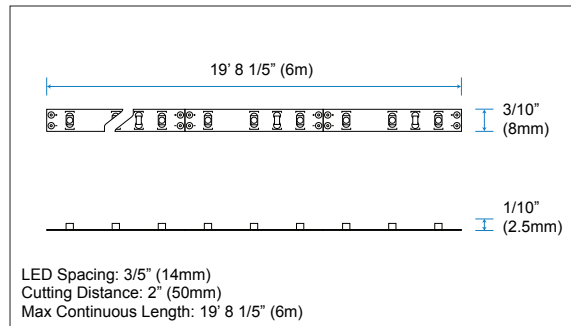

Output:

| | |
|------------------------|--|
| Delivered Lumens | 13.03 lm / ft |
| CCT | N/A |
| Chromaticity Ordinates | x: 0.0000 y: 0.0000 u: 0.0000 v: 0.0000 |
| Color Bin Tolerance | N/A |
| Efficacy (lm/w) | 11.23 |
| Wavelength | 470nm |
| Lumen Maintenance | 70,000 Hours L70 @ 25°C : 90,000 Hours L50 @ 25°C 50,000 Hours L70 @ 50°C : 70,000 Hours L50 @ 50°C |
| Testing Data | Light Data LM-79-08 & LM-80-08 |

Illuminance at a Distance: Data Shown for 120°

(For lux multiply fc by 10.7)

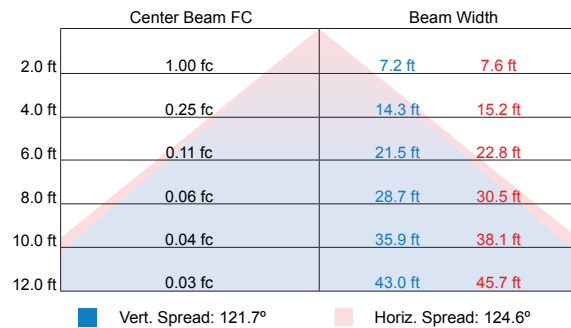

Electrical:

| | |
|-------------------|---|
| Input Voltage | 12v DC |
| Power Consumption | 1.16w / ft (0.10A) - Varies based on length of run & driver |
| Power Factor | ≤ 1 |
| Dimming | 100-277v 0-10v & Magnetic Low Voltage |
| Emergency | N/A |

Polar Candela Distribution:

Data Shown for 120°

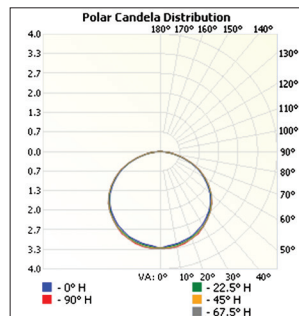

Lumens per Zone:

| Zone | Lumens | % Total |
|--------|--------|---------|
| 0-10 | 0.38 | 2.92% |
| 10-20 | 1.10 | 8.44% |
| 20-30 | 1.71 | 13.12% |
| 30-40 | 2.14 | 16.42% |
| 40-50 | 2.33 | 17.88% |
| 50-60 | 2.21 | 16.96% |
| 60-70 | 1.77 | 13.58% |
| 70-80 | 1.06 | 8.14% |
| 80-90 | 0.34 | 2.61% |
| 90-100 | 0.00 | 0.00% |

Physical:

| | |
|-----------------------|---|
| Applications | Cabinet, Cove, Display, Niches, Perimeter Lighting |
| Dimensions | Length 19' 8 1/5" (6m) Width 3/10" (8mm) Height 1/10" (2.5mm) |
| Weight | 3.9 oz (110g) Per Reel |
| Construction | Constant Voltage Design Protects LEDs And Prolongs Life. White FPCB |
| Thermal Management | N/A |
| Optics | N/A |
| Fixture Connections | Push To Fit Connectors |
| Operating Temperature | -22°F ~ 122°F (-30°C ~ 70°C) |
| Storage Temperature | -40°F ~ 176°F (-40°C ~ 80°C) |
| Humidity | 0-95% Non Condensing |

| | | | |
|---------------|--|--|--|
| Project Name: | | | |
| Notes: | | | |

SPECIFICATION

Zonal Lumen Summary:

| Zone | Lumens | % Lamp | % Fixt |
|--------|--------|--------|--------|
| 0-30 | 3.19 | N.A. | 24.50% |
| 0-40 | 5.33 | N.A. | 40.90% |
| 0-60 | 9.87 | N.A. | 75.70% |
| 60-90 | 2.82 | N.A. | 21.60% |
| 0-90 | 13.03 | N.A. | 100% |
| 90-180 | 0.00 | N.A. | 0.00% |
| 0-180 | 13.03 | N.A. | 100% |

Luminance Data (cd/sq.m):

| Angle in Degrees | Average 0-Deg | Average 45-Deg | Average 90-Deg |
|------------------|---------------|----------------|----------------|
| 45 | 4740 | 4918 | 4999 |
| 55 | 4767 | 4946 | 5006 |
| 65 | 4656 | 4900 | 4954 |
| 75 | 4243 | 4509 | 4464 |
| 85 | 4069 | 4069 | 4069 |

CIE 1931 Chromaticity Diagram:

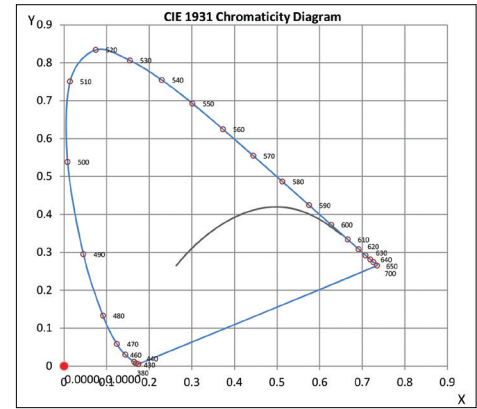

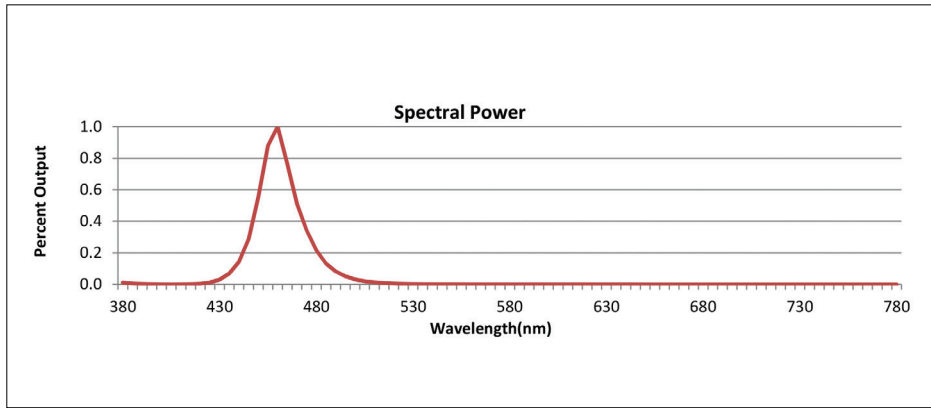

Spectral Power:

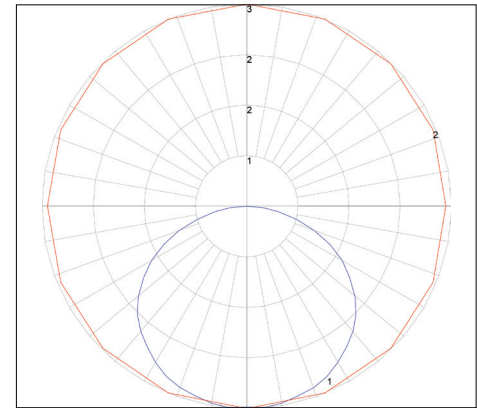

Polar Graph: Data Shown for 120°



Accessories:

| | | |
|---|---|---|
|  |  |  |
| MRTA25 10' Leader Cable | MRTA26 EZ - Connector | MRTA27 4' EZ - Connector for STARFLEX |
| Connects STARFLEX to Power Supply | Connects Two STARFLEX Together | Connects Two STARFLEX And Allows for Flexible Corner Bends |
| Connector Dim. L: 1/2" (13mm) W: 1/5" (6mm) H: 1/10" (2mm) | L: 1/2" (13mm) W: 2/5" (10mm) H: 1/10" (2mm) | Connector Dim. L: 1/2" (13mm) W: 1/5" (6mm) H: 1/10" (2mm) |

Standards and Certifications:





| | |
|---------------|--|
| Certification | Tested to UL & CSA by ETL For Use in USA & CANADA, Complies with California Title 24 Requirements, Lighting Facts. Exceeds ANSI C78.377A, CE & RoHS Compliant. |
| Class | Class 3 |
| Environment | Dry Location - IP20 |
| Warranty | 5 Year Limited Warranty |

Ordering:

| | |
|------|---------------|
| SKU: | STARFLEX-BLUE |
|------|---------------|

SPECIFICATION

| Non Dimming | | Voltage Range | Wattage | IP Rating | Dimension |
|-------------|---|---------------|---------|-----------|---|
| MP16 |  | 100-277v AC | 132w | IP67 | 8 7/10" x 2 7/10" x 1 1/2" (222mm x 68mm x 39mm) |

| 0-10v Dimming | | Voltage Range | Wattage | IP Rating | Dimension |
|---------------|--|---------------|---------|-----------|---|
| MP05 |  | 347v AC | 60w | IP66 | 9 2/5" x 1 7/10" x 1 3/10" (240mm x 43mm x 32mm) |
| MP18N |  | 100-277v AC | 60w | IP66 | 9 2/5" x 1 7/10" x 1 3/10" (240mm x 43mm x 32mm) |
| MP86 |  | 100-277v AC | 100w | IP66 | 9 1/2" x 2 3/10" x 1 1/2" (241mm x 58mm x 37mm) |
| MP88 |  | 100-277v AC | 150w | IP66 | 9 1/2" x 2 3/5" x 1 3/5" (241mm x 67mm x 40.5mm) |

Ordering:

Sample SKU: MP05