

SPECIFICATION

Dimmable Low Profile LED Linear Flex System:

STARFLEX has set the standard for ultra flexible SSL illumination. Easy installation is achieved with simple hand tools and rapid push to fit connectors. Can be cut every 2 inches. Easy peel 3M backing for fixing to most surfaces. High light output. No UV or IR. Dimmable with choice of MODA drivers. A perfect low energy, low heat output solution for cove, niche, cabinet and display applications. See MODA Metal® for extrusion options.



Dimensions:

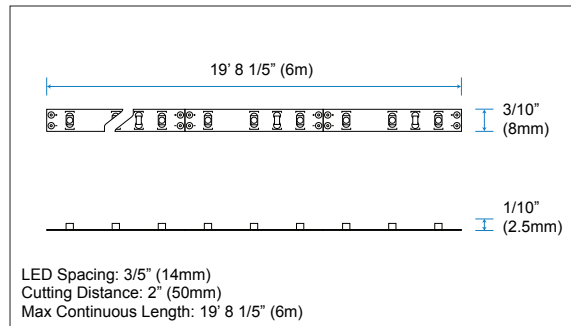

Output:

Delivered Lumens	12.57 lm / ft
CCT	N/A
Chromaticity Ordinates	x: 0.6933 y: 0.3054 u: 0.5254 v: 0.5207
Color Bin Tolerance	N/A
Efficacy (lm/w)	9.60
Wavelength	627nm
Lumen Maintenance	70,000 Hours L70 @ 25°C : 90,000 Hours L50 @ 25°C 50,000 Hours L70 @ 50°C : 70,000 Hours L50 @ 50°C
Testing Data	Light Data LM-79-08 & LM-80-08

Illuminance at a Distance: Data Shown for 120°

(For lux multiply fc by 10.7)

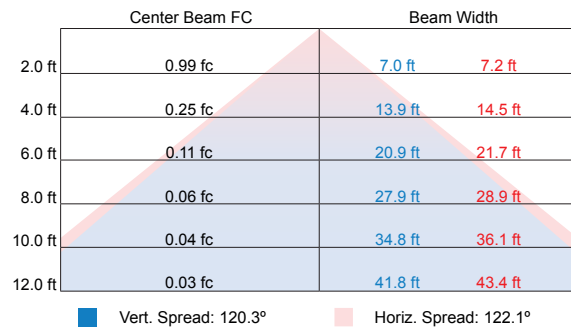

Electrical:

Input Voltage	12v DC
Power Consumption	1.31w / ft (0.11A) - Varies based on length of run & driver
Power Factor	≤ 1
Dimming	100-277v 0-10v & Magnetic Low Voltage
Emergency	N/A

Polar Candela Distribution:

Data Shown for 120°

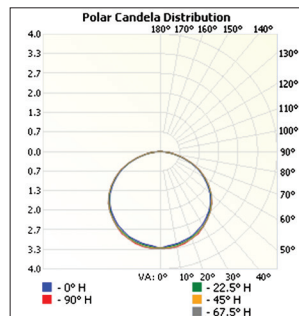

Lumens per Zone:

Zone	Lumens	% Total
0-10	0.38	3.02%
10-20	1.09	8.67%
20-30	1.67	13.29%
30-40	2.07	16.47%
40-50	2.23	17.74%
50-60	2.12	16.87%
60-70	1.70	13.52%
70-80	1.01	8.04%
80-90	0.31	2.47%
90-100	0.00	0.00%

Physical:

Applications	Cabinet, Cove, Display, Niches, Perimeter Lighting
Dimensions	Length 19' 8 1/5" (6m) Width 3/10" (8mm) Height 1/10" (2.5mm)
Weight	3.9 oz (110g) Per Reel
Construction	Constant Voltage Design Protects LEDs And Prolongs Life. White FPCB
Thermal Management	N/A
Optics	N/A
Fixture Connections	Push To Fit Connectors
Operating Temperature	-22°F ~ 122°F (-30°C ~ 70°C)
Storage Temperature	-40°F ~ 176°F (-40°C ~ 80°C)
Humidity	0-95% Non Condensing

Project Name:			
Notes:			

SPECIFICATION

Zonal Lumen Summary:

Zone	Lumens	% Lamp	% Fixt
0-30	3.14	N.A.	25.00%
0-40	5.20	N.A.	41.40%
0-60	9.55	N.A.	76.00%
60-90	2.71	N.A.	21.60%
0-90	12.57	N.A.	100%
90-180	0.00	N.A.	0.00%
0-180	12.57	N.A.	100%

Luminance Data (cd/sq.m):

Angle in Degrees	Average 0-Deg	Average 45-Deg	Average 90-Deg
45	4579	4708	4692
55	4587	4767	4767
65	4575	4656	4656
75	4155	4288	4243
85	3544	3675	3544

CIE 1931 Chromaticity Diagram:

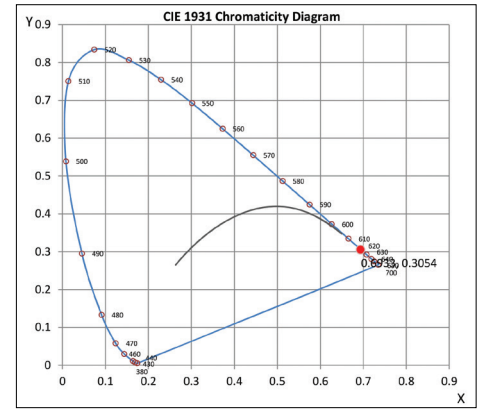

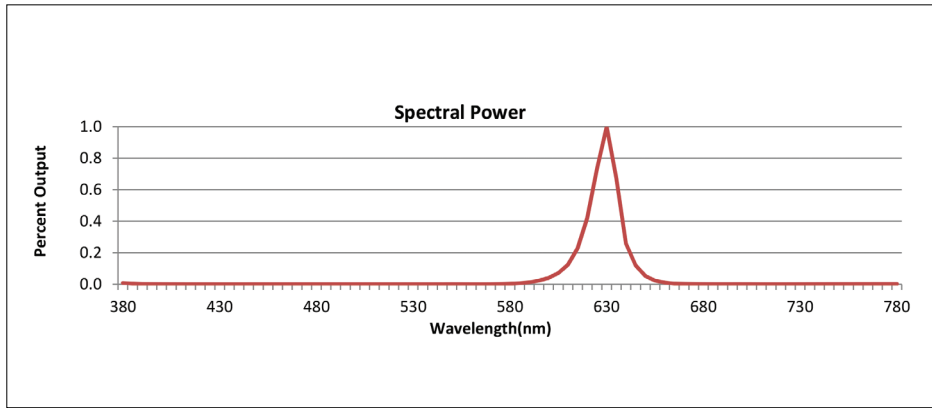

Spectral Power:

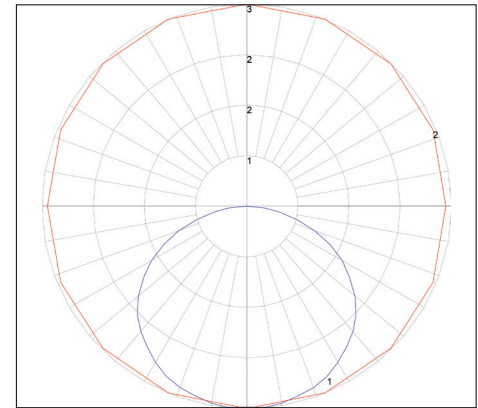

Polar Graph: Data Shown for 120°



Accessories:

		
MRTA25 10' Leader Cable	MRTA26 EZ - Connector	MRTA27 4' EZ - Connector for STARFLEX
Connects STARFLEX to Power Supply	Connects Two STARFLEX Together	Connects Two STARFLEX And Allows for Flexible Corner Bends
Connector Dim. L: 1/2" (13mm) W: 1/5" (6mm) H: 1/10" (2mm)	L: 1/2" (13mm) W: 2/5" (10mm) H: 1/10" (2mm)	Connector Dim. L: 1/2" (13mm) W: 1/5" (6mm) H: 1/10" (2mm)

Standards and Certifications:





Certification	Tested to UL & CSA by ETL For Use in USA & CANADA, Complies with California Title 24 Requirements, Lighting Facts. Exceeds ANSI C78.377A, CE & RoHS Compliant.
Class	Class 3
Environment	Dry Location - IP20
Warranty	5 Year Limited Warranty

Ordering:

SKU:	STARFLEX-RED
------	--------------

SPECIFICATION

Non Dimming		Voltage Range	Wattage	IP Rating	Dimension
MP16		100-277v AC	132w	IP67	8 7/10" x 2 7/10" x 1 1/2" (222mm x 68mm x 39mm)

0-10v Dimming		Voltage Range	Wattage	IP Rating	Dimension
MP05		347v AC	60w	IP66	9 2/5" x 1 7/10" x 1 3/10" (240mm x 43mm x 32mm)
MP18N		100-277v AC	60w	IP66	9 2/5" x 1 7/10" x 1 3/10" (240mm x 43mm x 32mm)
MP86		100-277v AC	100w	IP66	9 1/2" x 2 3/10" x 1 1/2" (241mm x 58mm x 37mm)
MP88		100-277v AC	150w	IP66	9 1/2" x 2 3/5" x 1 3/5" (241mm x 67mm x 40.5mm)

Ordering:

Sample SKU: MP05