

SPECIFICATION

Dimmable Wet Location LED Linear Flex System:

Very high output linear flex system. Superior level of illumination with a high level of delivered lumens per foot. Over 600 high quality SMD LED's per reel and a unique high copper content FPCB design that allows for stable and consistent thermal management. IP67 wet location rated. Fully field cuttable every 1" and has available accessories for easy field installation. Fully dimmable through use of MODA LIGHT drivers. See MODA Metal® for extrusion options.



Dimensions:

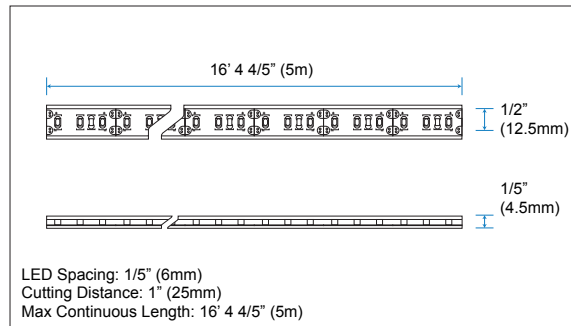

Output:

Delivered Lumens	22.22 lm / ft
CCT	N/A
Chromaticity Ordinates	x: 0.6472 y: 0.3528 u: 0.4360 v: 0.5346
Color Bin Tolerance	N/A
Efficacy (lm/w)	4.68
Wavelength	590nm
Lumen Maintenance	70,000 Hours L70 @ 25°C : 90,000 Hours L50 @ 25°C 50,000 Hours L70 @ 50°C : 70,000 Hours L50 @ 50°C
Testing Data	Light Data LM-79-08 & LM-80-08

Illuminance at a Distance: Data Shown for 120°

(For lux multiply fc by 10.7)

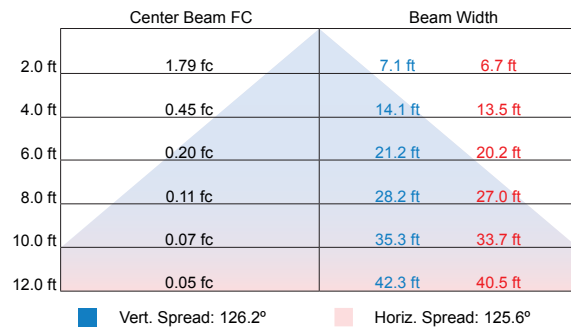

Electrical:

Input Voltage	12v DC
Power Consumption	4.75w / ft (0.09A) - Varies based on length of run & driver
Power Factor	≤ 1
Dimming	100-277v 0-10v & Magnetic Low Voltage
Emergency	N/A

Polar Candela Distribution:

Data Shown for 120°

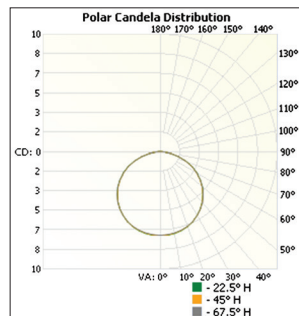

Lumens per Zone:

Zone	Lumens	% Total
0-10	0.68	3.06%
10-20	1.96	8.82%
20-30	3.03	13.64%
30-40	3.74	16.83%
40-50	3.99	17.96%
50-60	3.72	16.74%
60-70	2.93	13.19%
70-80	1.71	7.70%
80-90	0.47	2.12%
90-100	0.00	0.00%

Physical:

Applications	Wet Locations, Cabinet, Cove, Display, Niches, Perimeter Lighting
Dimensions	Length 16' 4 4/5" (5m) Width 1/2" (12.5mm) Height 1/5" (4.5mm)
Weight	11.2 oz (317.5g) Per Reel
Construction	Constant Voltage Design Protects LEDs And Prolongs Life. White FPCB Inside a Silicone Sleeve
Thermal Management	N/A
Optics	N/A
Fixture Connections	Solder joints
Operating Temperature	-22°F ~ 122°F (-30°C ~ 70°C)
Storage Temperature	-40°F ~ 176°F (-40°C ~ 80°C)
Humidity	0-95% Non Condensing

Project Name:			
Notes:			

SPECIFICATION

Zonal Lumen Summary:

Zone	Lumens	% Lamp	% Fixt
0-30	5.67	N.A.	25.50%
0-40	9.41	N.A.	42.30%
0-60	17.11	N.A.	77.00%
60-90	4.64	N.A.	20.90%
0-90	22.22	N.A.	100%
90-180	0.00	N.A.	0.00%
0-180	22.22	N.A.	100%

Luminance Data (cd/sq.m):

Angle in Degrees	Average 0-Deg	Average 45-Deg	Average 90-Deg
45	3780	3773	3751
55	3786	3759	3687
65	3670	3633	3572
75	3276	3236	3076
85	2254	2373	2136

CIE 1931 Chromaticity Diagram:

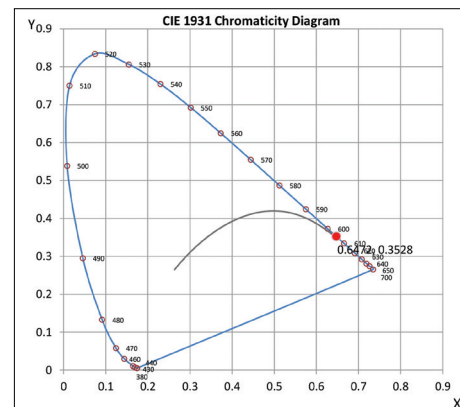



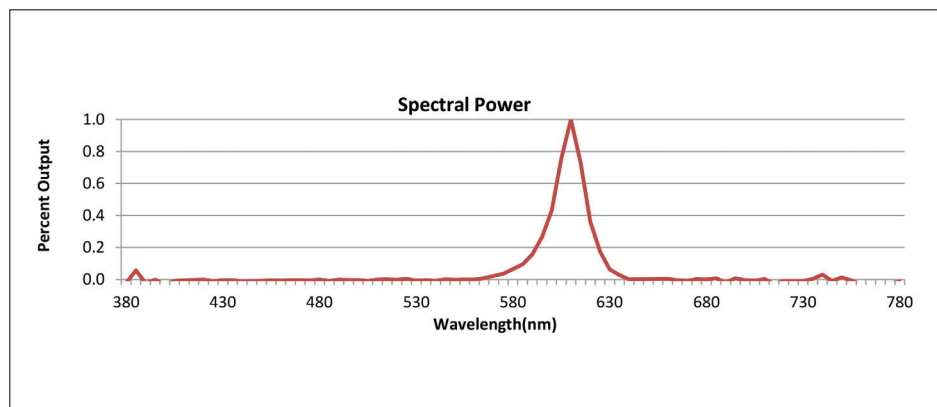

Spectral Power:

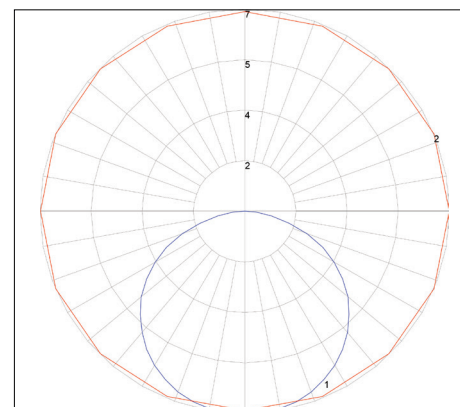

Polar Graph: Data Shown for 120°



Accessories:

			
MRTA61 Mounting Clips	MRTA63 End Cap	MRTA62 3oz 3M Marine Grade Super Silicone Sealant	MRTA62-XL 1/10 gal 3M Marine Grade Super Silicone Sealant
Screws Into Surface To Hold SUPER-AQUAFLEX	Terminates SUPER-AQUAFLEX To Protect FPCB From Dust or Water	Applied Between SUPER-AQUAFLEX, Connectors or End Caps to Seal From Exposure to Moisture	Applied Between SUPER-AQUAFLEX, Connectors or End Caps to Seal From Exposure to Moisture
L: 1 1/5" (30mm) W: 1/5" (5mm) H: 1/5" (5mm) 2 Screws 1/2" (13mm)	L: 3/5" (15mm) W: 1/5" (5mm) H: 1/5" (5mm)		

Standards and Certifications:





Certification	Tested to UL & CSA by ETL For Use in USA & CANADA, Complies with California Title 24 Requirements, Lighting Facts. Exceeds ANSI C78.377A, CE & RoHS Compliant.
Class	Class 3
Environment	Wet Location - IP67
Warranty	5 Year Limited Warranty

Ordering:

SKU:	SUPER-AQUAFLEX-AMBER
------	----------------------

SPECIFICATION

Non Dimming		Voltage Range	Wattage	IP Rating	Dimension
MP16		100-277v AC	132w	IP67	8 7/10" x 2 7/10" x 1 1/2" (222mm x 68mm x 39mm)

0-10v Dimming		Voltage Range	Wattage	IP Rating	Dimension
MP05		347v AC	60w	IP66	9 2/5" x 1 7/10" x 1 3/10" (240mm x 43mm x 32mm)
MP18N		100-277v AC	60w	IP66	9 2/5" x 1 7/10" x 1 3/10" (240mm x 43mm x 32mm)
MP86		100-277v AC	100w	IP66	9 1/2" x 2 3/10" x 1 1/2" (241mm x 58mm x 37mm)
MP88		100-277v AC	150w	IP66	9 1/2" x 2 3/5" x 1 3/5" (241mm x 67mm x 40.5mm)

Ordering:

Sample SKU: MP05